

User manual - Prowise Touchscreen



This user manual is applicable to Prowise Touchscreens with model number:

- PW.1.15055.0001
- PW.1.15065.0001
- PW.1.15075.0001
- PW.1.15086.0001

1. Index

1. Index	2
2. Important safety instructions	4
2.1. Safety	4
2.2. Placement	4
2.3. Repair	5
2.4. Environment	5
2.5. Recycling and disposal	5
Packaging	5
Device	6
Batteries	6
3. Installation	6
3.1. Place of installation	7
3.2. Cabling	7
3.3. WiFi module	8
3.4. Install the OPS PC module	9
4. At first glance	11
4.1. Product Specifications	12
4.2. Package contents	15
4.3. Product overview	17
4.4. Touchscreen control	18
4.5. The control button	20
4.6. Microphone	20
4.7. NFC card reader and remote control receiver	21
4.8. ProWrite® technology	22
4.9. Cleaning	23
5. Getting started	24
5.1. Turn the touchscreen on and off	24
5.2. Starting your device for the first time	27
5.3. Connect to a network	28
5.4. Adjust volume	29
6. Prowise Central	30
6.1. Prowise Central home	30
6.2. The Prowise Central menu	31
7. Adjust settings	32
8. OTA (Over The Air) updates	32
9. Remote control	33
9.1. Schematic view and explanation of the buttons	33

9.2. Angle at which the remote control is used	35
9.3. Replacing the batteries of the remote control	36
10. Connect peripherals	37
10.1. Connect the Prowise Touchscreen to an external PC	37
10.2. Connecting the Prowise Touchscreen to audio equipment	38
10.2.1. Connecting headphones	38
10.2.2. Connecting an amplifier	39
10.2.3. Connecting using the HDMI port (ARC)	40
10.2.4. Connecting using the HDMI port (CEC)	41
Appendix	42
RS232 protocol and code list	42
Protocol description	43
RS232 code list	43
Polling code list	46

2. Important safety instructions



WARNING! Before using the Prowise Touchscreen, please read this user manual and the **safety instructions** (separate document) carefully. Follow the warnings stated on the device, the user manual and the safety instructions. Always keep the safety instructions and the user manual within reach.

2.1. Safety

- Never open the housing of the touchscreen! You can get an electric shock or cause a short circuit.
- Do not use the touchscreen during thunderstorms and unplug the power cable to avoid damage due to a lightning strike.
- Make sure your touchscreen does not get wet! This could lead to short circuiting and electrocution hazard. Do not install the device close to water and do not place objects containing liquid on- or next to it.
- Excessive sound volume causes permanent hearing damage. If the device is used at high sound volume for an extended period of time, it can cause hearing damage to the listener.
- Only use components and accessories supplied by Prowise.
- Always turn off the touchscreen and unplug it from the electrical outlet when changing a module.
- Do not insert objects into the openings of the touchscreen that are not intended for this purpose. This could result in a short circuit or even fire.

2.2. Placement

- We recommend you don't install the touchscreen yourself or by a third party. Let Prowise or a certified Prowise partner install or mount the touchscreen to avoid possible damage. Prowise can not be held responsible for any damage or injury caused by incorrect installation by third parties. Damage due to incorrect installation by third parties will not be covered by the warranty.
- Do not install or place the touchscreen onto an unstable wall or floor.
- Do not use the touchscreen in an industrial environment where it will frequently get exposed to vibrations and dust.
- Do not place the touchscreen close to equipment that generates heat.
- Make sure that all ventilation openings, located at the back of the touchscreen, stay uncovered, so hot air can escape.
- Only connect the touchscreen to an earthed electrical socket.

2.3. Repair

Never repair the touchscreen yourself!



WARNING! *Warning for electrified parts! Never open the housing of the touchscreen! You can get an electric shock, cause a short circuit or even a fire. This can cause injuries or damage to yourself and/or the touchscreen.*

Always contact Prowise or a certified partner in case of a defect, to avoid damage. Contact information can be found at: www.prowise.com/en/contact.

2.4. Environment

- Unplug the power cable if the screen will not be used for an extended period of time.
- The power consumption in standby mode is <0.5 watts.
- The Prowise Touchscreen is ENERGY STAR-certified.
- When the touchscreen is no longer usable, it can be disposed of at a designated collection point.



PLEASE NOTE! *When WOL and WOS are activated, the power consumption in standby mode will increase!*

2.5. Recycling and disposal

If you have questions about the correct disposal of your touchscreen, please contact Prowise or a certified partner.



Packaging

The device is packaged to prevent transport damage. Packaging consists of resources that can be reused or recycled.

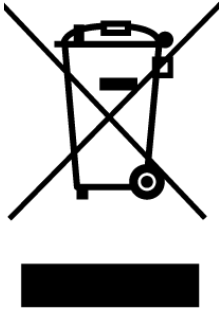

Device

Do not dispose of the device with household waste at the end of its lifespan. Ask about the possibilities for an environmental friendly and responsible method of disposal.



Batteries

Depleted or defective batteries do not belong in the household waste. Dispose of them at a collection point for empty batteries. The remote control uses 1.5V AAA batteries.

3. Installation

A Prowise certified mechanic will install the Prowise Touchscreen on delivery and will ensure the screen is ready for use. We do not recommend it, however if you want to install the screen yourself or by someone else, then please follow the steps below:

- Do not install the touchscreen alone.
- Use a certified Prowise wall bracket to install the Prowise Touchscreen on a wall.
- Use a Prowise VESA bracket when assembling the screen on a Prowise lift system.
- Please ensure the wall is strong enough to carry the weight of the touchscreen.
- Connect the cables (which cables you require depend on the external devices you use or other external sources like a lift system).
- If you are using an OPS PC module, ensure the module is inserted and locked correctly. Install the PC module as described in the chapter 'Install PC module'.

- Make sure to only connect the power cable when the above elements have been connected and only use the power cable supplied by Prowise.



CAUTION! *Prowise can not be held responsible for any damage or injury caused by the incorrect installation of the touchscreen done by third parties. Damage to the touchscreen, caused by incorrect installation by third parties, will not be covered by the warranty. Always contact Prowise or a certified partner if you have any questions about the installation.*

3.1. Place of installation

Please follow the instructions below, these will help guarantee reliable functioning and a long lifespan of your touchscreen.

Keep the touchscreen and all connected devices away from water and avoid dust and heat. Do not place the touchscreen near devices which produce heat or in the vicinity of water. Non-compliance with these instructions can lead to faults or damage to the touchscreen.

The Prowise Touchscreen can be used at an ambient temperature from 0 °C to +38 °C (32 °F to 100,4 °F) and relative humidity from 10% to 90% (without condensation).

When switched-off, the touchscreen can be stored at a temperature from -20 °C to 60 °C (-4 °F to 140 °F) and relative humidity from 10% to 90% (without condensation).

Install the touchscreen on a stable, vibration-free floor/wall to avoid damage to the touchscreen. Make sure that all of the ventilation openings, located at the back of the screen, stay uncovered, so hot air can escape.



WARNING! *Disconnect the power cable during a thunderstorm. For extra safety, we recommend using an overvoltage protection device, to prevent the touchscreen from sustaining damage as a result of power surges or lightning strikes.*

3.2. Cabling

Only use the power cable supplied by Prowise to connect the Prowise Touchscreen to the mains power supply. The touchscreen must be placed close to the electrical outlet and the electrical outlet should be

easy to reach. Cables should not be laid in the walkway to avoid anyone stepping on them or tripping over them. Do not place any objects on the cables to avoid damaging them. Prevent electrical overloads when using a distributing plug, as this can lead to a short circuit.

For extra safety, we recommend using an overvoltage protection device to prevent the touchscreen from sustaining damage as a result of power surges or lightning strikes.



CAUTION! Only plug the power cable into grounded electrical outlets with AC 100-240V ~50/60Hz. If you are not sure about the power supply at the installation location, consult your energy company.

3.3. WiFi module

The Prowise Touchscreen is equipped with a WiFi module. Follow the steps below to successfully install the WiFi module.

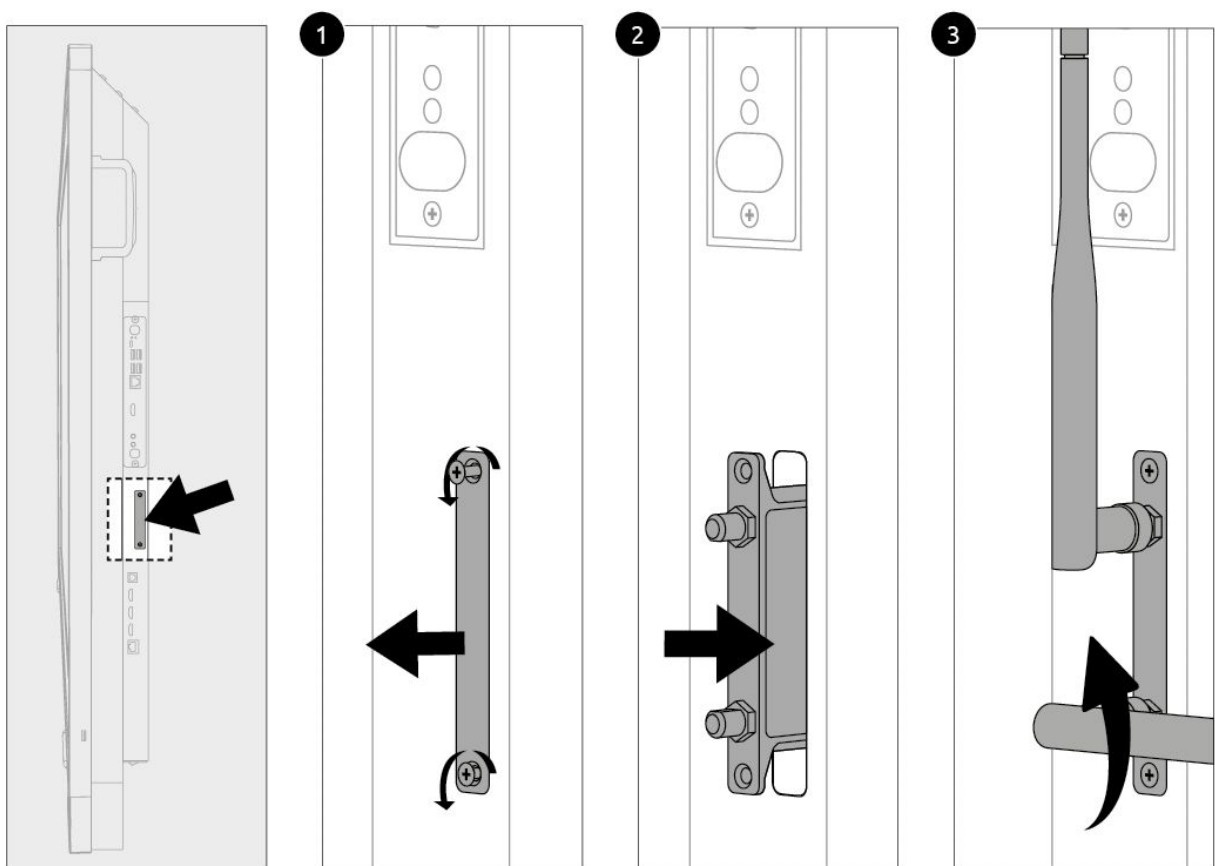



HAZARD WARNING! Choking hazard. This product contains small parts that form a choking hazard for children. Keep this product out of reach for children when not installed into the touchscreen.



WARNING! Please make sure the power cable of the Prowise Touchscreen is disconnected before installation.

3.4. Install the OPS PC module

Follow the steps below to install the OPS PC module:

(Please note the OPS PC module is optional)



CAUTION! Please ensure the power cable is not connected to the main power supply while installing the OPS PC module.

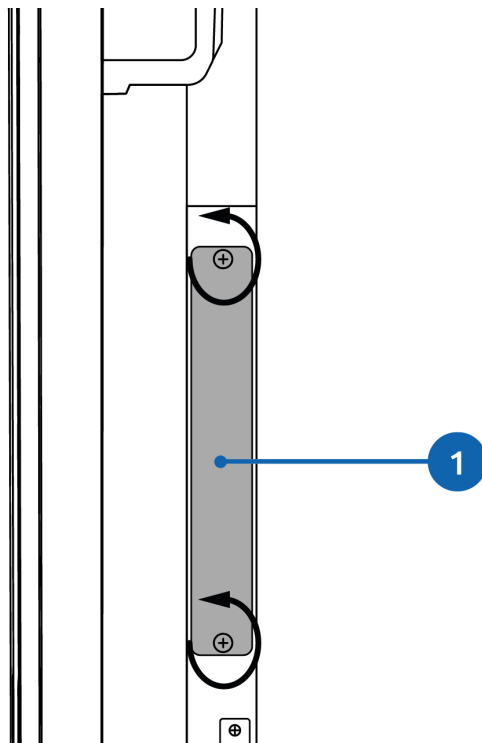

1. Unscrew the screws

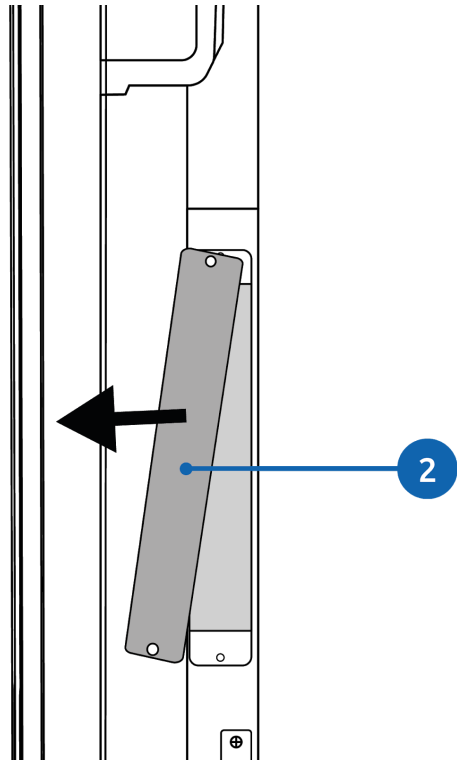

2. Remove the cover plate

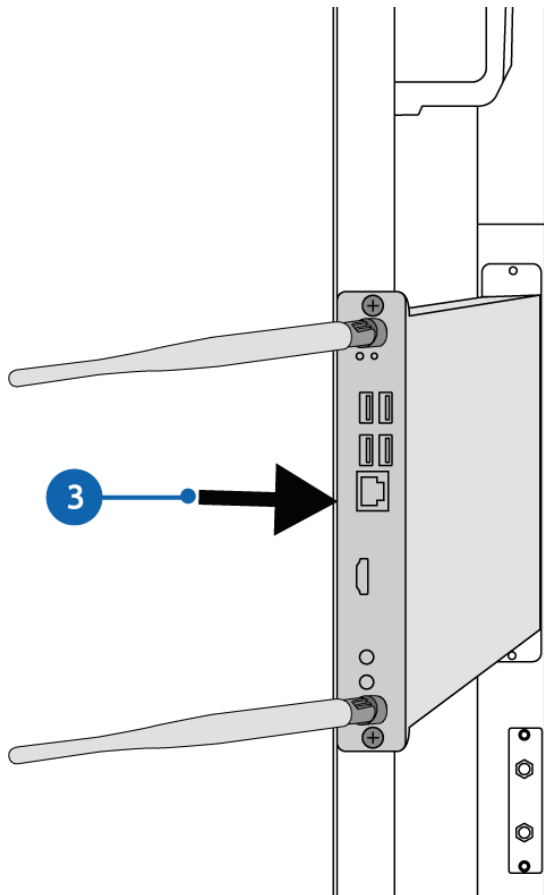

3. Insert the OPS PC module into the slot

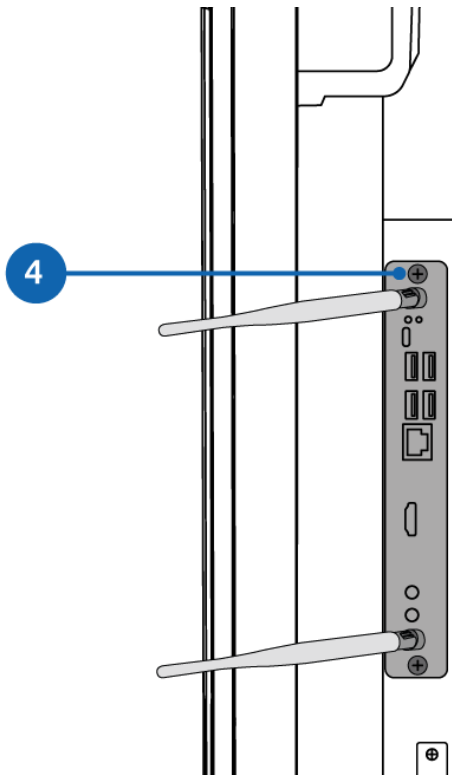

4. Tighten the lock screw of the PC module

4. At first glance

We recommend not to install the touchscreen yourself or by a third party. Have Prowise or a certified partner install or mount your touchscreen, to avoid possible damage.

Always adjust the screen to the correct height before use. Avoid standing in a stooped or bent posture and ensure that the ends of the screen are located within arm's reach.

In the optimal position of the screen, you can touch both the top and bottom of the screen without needing to stoop or reach far up. By positioning the screen properly, you can avoid physical problems that could result from an incorrect work posture. Avoid physical complaints caused by a poor posture.



DANGER! Risk of injury. Do not stand on a chair, stool or other object to operate the touchscreen. This especially applies to children! This involves a risk of falling that could result in serious injury. Ensure that the screen is installed at the correct height or that the lift is set to the correct height when the screen is used.

4.1. Product Specifications

Screen	
Bezel colour	Brushed aluminium (grey)
Diagonal	55 inch / 65 inch / 75 inch / 86 inch
Panel type	Ultra HD LED - IPS
Resolution	3840 x 2160 @ 60Hz
Glass plate	Anti-Glare Pro
Glass thickness	4 mm / 0.16 inches
Glass hardness	Mohs 7
Aspect ratio	16:9
Contrast ratio	1200:1
Brightness	350 cd/m2
Number of colours	10 Bit (1.07B)
Viewing angle	178°
Panel refresh rate	60Hz
Modules	
PC module slot	Yes, OPS slot
Touch type	
Type	HApró 2
Multi-touch	Yes (20 points)
Multi-writing	Yes (10 points)
Auto-calibration	Yes
Resistant to sunlight	Yes
Supported OS	Windows 7, 8.1 & 10/Mac OS/Linux/Android and Chrome OS
Audio	
Speakers	2.1 sound (3 speakers)

Front speaker power	2 x 16W (8Ω)
Subwoofer power	1 x 15W (8Ω)
Dolby Audio	Yes

Manufactured under license of Dolby Laboratories.
Dolby, Dolby Audio and the double-D symbol are trademarks of Dolby Laboratories.

Microphone	
Type	Microphone array
Number of microphones	4
Auto switch (Windows/Central)	Yes

ProWrite®	
Number of pens	2 passive pens
Multi-color writing	Yes
Multi-size writing	Yes

Special features	
Prowise Central	Yes
Over The Air updates (OTA)	Yes
NFC reader/writer	Yes

Connections	
HDMI 2.0	2
HDMI 2.0 (CEC & ARC)	1 (with CEC and ARC support)
Total HDMI 2.0	3
VGA / DVI	Optional
DisplayPort	Optional
Audio output analog	1 (3.5mm headphone Jack PJ3591 female)
Audio output digital	1 (RCA composite female)
RS232 control	1 (Sub-D, 9 pins)
AV in	1 (including adapter to 3 x composite)
USB touch port	1 (USB-B female)

USB 2.0	2
USB 3.0	1
Wi-Fi for online updates	Yes

General information

Voltage	~ 100-240 V (50/60Hz)
VESA standard	55": 400x400 65": 400x400 75": 600x400 86": 700x400
Certifications	CE: EMC+LVD/FCC-IC/RoHS/UL+CB, RCM and ENERGY STAR
Warranty	5 years standard (up to 8 years)

Environmental conditions

Operation temperature	0°C - 38°C / 32 - 100°F
Storage temperature	-20°C - 60°C / -4 - 140°F
Storage humidity	10% - 90%
Operation humidity	10% - 90%

4.2. Package contents

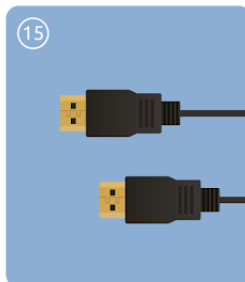
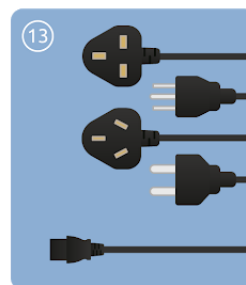
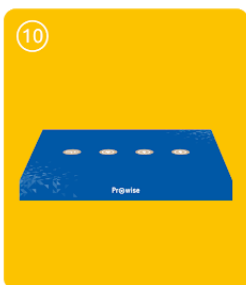
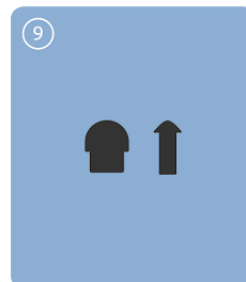
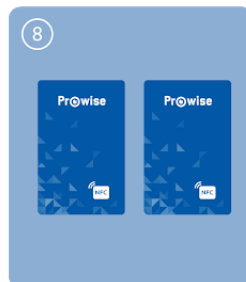
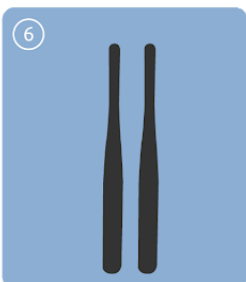
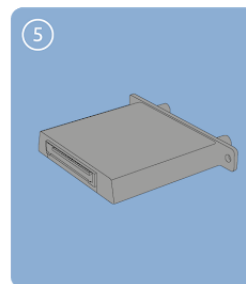
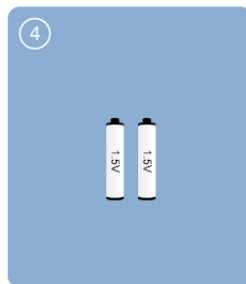

1. **Prowise Touchscreen**
2. **Accessory box:**
3. Remote control
4. Batteries 1.5 V AAA (2x)
5. WiFi module
6. WiFi antennas (2x)
7. ProWrite® dual writing pen (2x)
8. NFC cards (2x)
9. Pen tips (4x)
10. **Cable box:**
11. Safety instructions Prowise Touchscreen
12. User manual WiFi module
13. EU, UK and US power cable
14. USB touch cable
15. HDMI cable



WARNING! *Keep the packaging material, such as plastic foil, out of reach from children. Improper use of packaging materials can result in a suffocation hazard.*



PLEASE NOTE! *Check that what has been supplied is complete and contact our service desk within 5 days of delivery if it is incomplete. Please provide the serial number and a copy of the invoice.*

4.3. Product overview

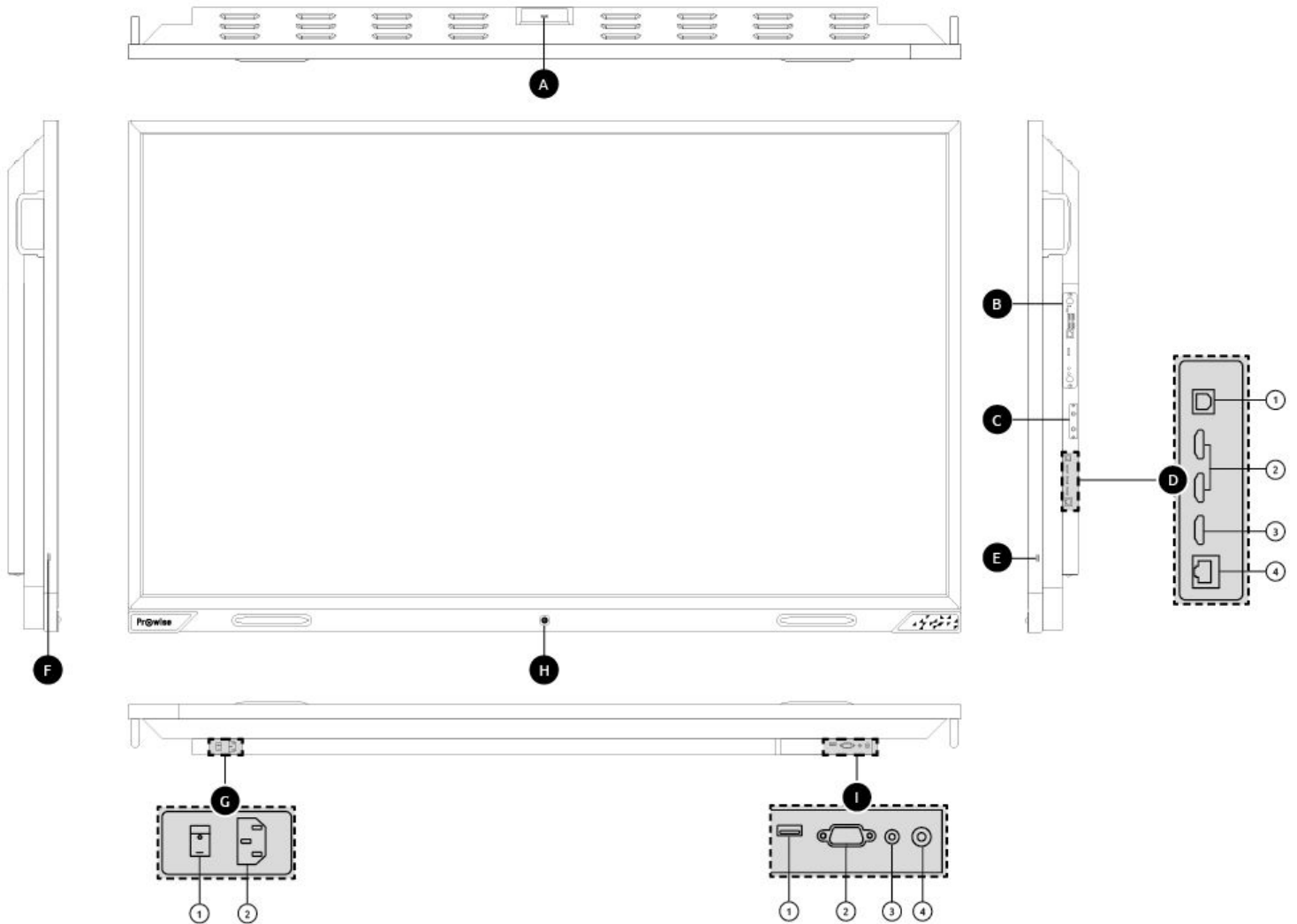



- A. USB 3.0 (external camera)
- B. OPS slot (side)
- C. WiFi Module slot (side)
- D. External inputs / outputs (side)
 - 1. USB Type-B
 - 2. HDMI 2.0 inputs
 - 3. HDMI 2.0 ARC
 - 4. LAN port
- E. USB 2.0
- F. USB 2.0
- G. AC-in and main power switch (bottom)

1. Main power switch
 2. AC input
- H. Control-Button (front)
- When screen is off:
- Activates screen
- When screen is on:
- Press < 1 seconds activates Prowise Central Menu
 - Hold > 1 seconds activates shut down
- I. Lift (Bottom)
1. USB 2.0 for lift control and service
 2. RS232
 3. Headphone
 4. Digital coax

4.4. Touchscreen control

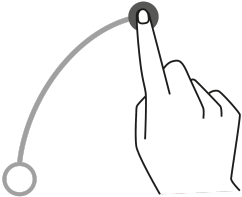
The Prowise Touchscreen is fitted with 20-points multi-touch. The screen recognises up to 20 simultaneous touchpoints. This allows you to use the touchscreen with multiple people at once.

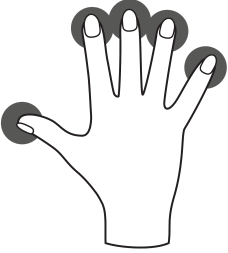
	Click	To click on a part of the screen, gently tap with one finger on the touchscreen.
	Drag	Tap with one finger on the item that you want to move and drag it to the new location without releasing your finger from the screen.

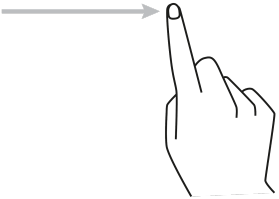
	<p>Open Prowise Central menu</p>	<p>Place five fingers of one hand on the screen for at least 2 seconds. The menu will appear.</p>
	<p>Right-click (context-menu) (PC module)</p>	<p>Tap and hold one finger on the screen for a few seconds for the right click function.</p>
	<p>Scroll</p>	<p>Slide one finger across the screen in the desired direction.</p>

The touchscreen can also be controlled by using a computer mouse or with the supplied remote control. Furthermore, you can use the control button, located in the center of the speaker bar of the touchscreen, to turn the touchscreen ON or OFF or to open the Central menu.

4.5. The control button

The control button can be found in the middle of the speaker bar of the touchscreen.

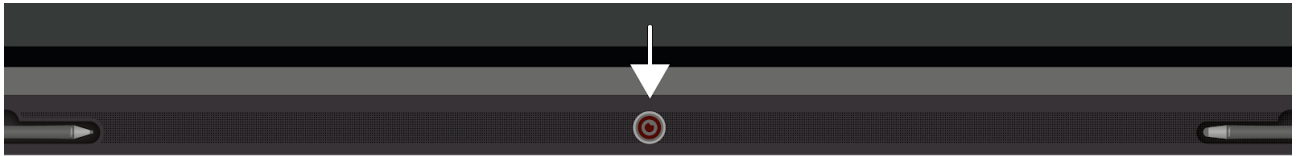

Control button

- When the touchscreen is in standby mode, short-press this button to turn it back on again.
- When the touchscreen is turned on, long-press this button to turn it off.
- When the touchscreen is turned on, short-press this button to open the Central menu.



The LED inside the control button indicates the touchscreen's status.

- The touchscreen is turned on: Blue
- Backlight is turned off: Blue
- Sleep mode: Flashing red (every 2 seconds)
- Standby mode: Red

4.6. Microphone

The Prowise Touchscreen has 4 wide area microphones. Thanks to these 4 wide area microphones, the recording quality will be excellent, making the Prowise Touchscreen ideal for video conferencing. Use the microphone in Prowise Central or if a PC module is installed.

4.7. NFC card reader and remote control receiver

The tab on the right-hand side of the speaker bar of the touchscreen, has various functions:



- Hold the NFC card in front of the tab to log in using NFC technology.
- The remote control's IR sensor is located here.



PLEASE NOTE! *To log in with an NFC card, the card must first be configured using the Prowise Central settings menu.*

4.8. ProWrite® technology

The Prowise Touchscreen is equipped with two pens. These are conveniently located at the front of the screen and will automatically snap into place when you hold a pen in front of the docking location.

What makes the ProWrite® technology and pen combination unique in the market is that the pen has 2 different tip sizes available to use when writing on the screen. The advantages of this are:

- Write small and switch to large without any software interaction
- Switch between colours by turning around the pen
- Write simultaneously in 2 different colours and sizes

Next to the uniquely designed pens we enhanced the technology to give you a better experience. The highlights of this are:

- Fast writing response
- Writing tip as small as 2mm
- Full support for Windows Ink
- 20-points touch support
- 10-points writing support

With this technology the Prowise Touchscreen is an ideal touchscreen for collaboration and writing.

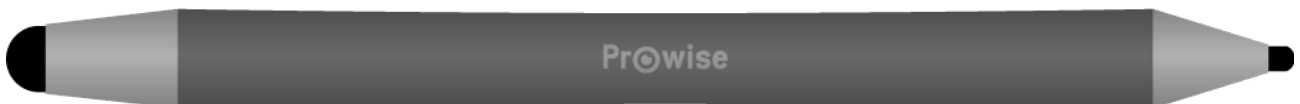

4.9. Cleaning

Clean the screen with a dry, lint-free, microfiber cloth. Ensure this cloth is free of impurities.

If you wish to use a cleanser, always use a cleanser recommended by Prowise. Do not use any aggressive cleansers as these can cause damage to the screen.

Never spray a cleanser directly onto the screen, apply it to a cloth first. The cloth may be slightly damp, but not wet, as this can cause damage to the screen.

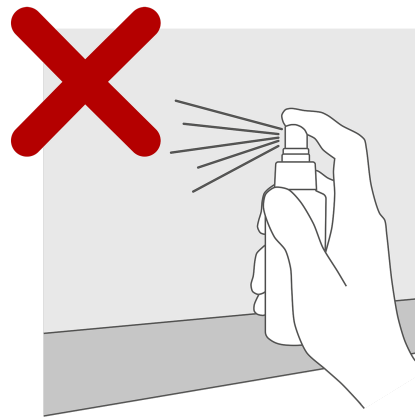
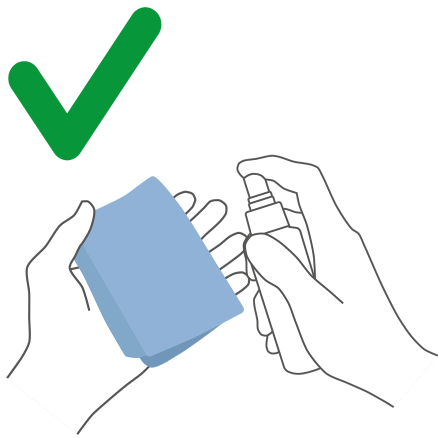

Gently wipe down the screen with the cloth. Clean the screen with gentle, circular movements without pressure to gain the best result. Never use an abrasive cleanser.

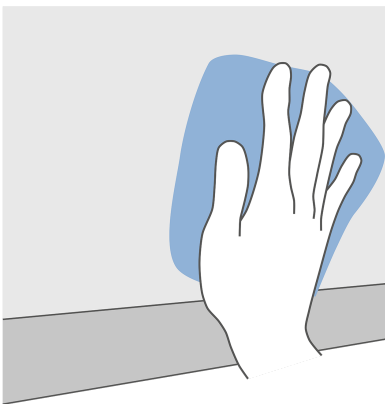



WARNING! *In the unlikely event that the touchscreen gets wet, do not turn the power on and do not insert the power cable into the electrical outlet. This can result in an electric shock. Should the touchscreen get wet when it's turned on, immediately turn off the power supply and disconnect the power cable of the touchscreen from the electrical outlet to avoid a short circuit.*



CAUTION! *Unplug the power supply before cleaning the screen.*

5. Getting started

5.1. Turn the touchscreen on and off

Turn on

1. Ensure the touchscreen is connected to the mains power supply.
2. Turn ON the power switch on the bottom left-hand side of the touchscreen.

There are a few different options to turn on the touchscreen once activated:

- Press the control button located in the middle of the speaker bar of the touchscreen
- Press the on/off button on the supplied remote control

Turn off

Using the on/off button of the control panel

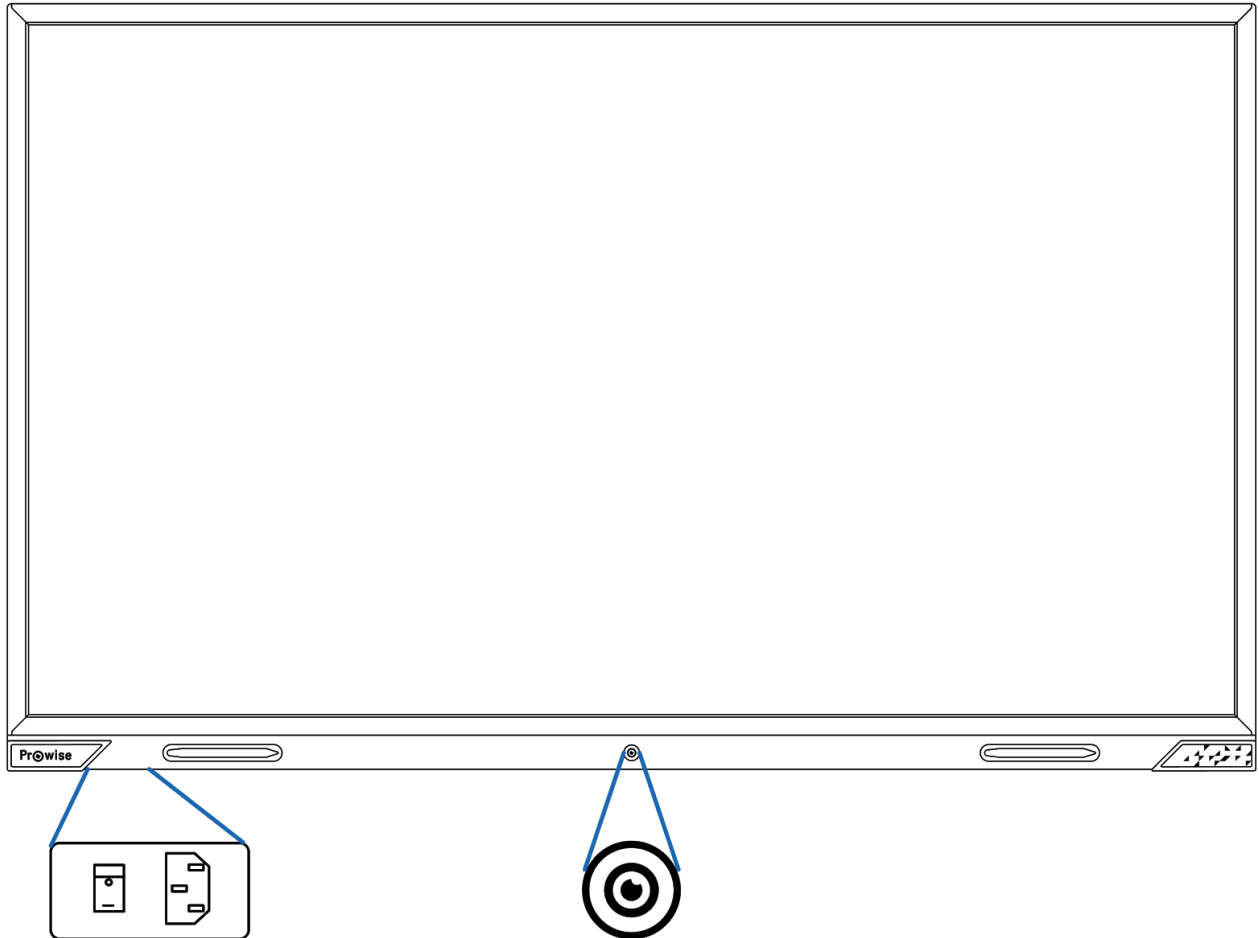

1. Press the control button in the middle of the speaker bar.
2. The notification 'The system will shut down in 15 seconds' will appear.
3. Select 'Shut down' if you wish to turn off the touchscreen or wait 15 seconds, to abort your touchscreen from closing down select the 'Cancel' button.
4. Turn off the main power supply by using the power switch on the left hand side of the touchscreen (see picture).

Using Prowise Central

1. Launch the Prowise Central Menu by placing five fingers of one hand on the screen, by pressing the menu tab on the right-hand side of the screen or by short pressing the control button of the touchscreen.
2. Open the sidebar.
3. Select the 'power' icon.
4. The notification 'The system will shut down in 15 seconds' will appear.
5. Select 'Shutdown' to shut the touchscreen down immediately, or wait 15 seconds for the touchscreen to shut down automatically. To abort the shutdown of your touchscreen select the 'Cancel' button.
6. Turn off the main power supply by using the power switch on the right hand side of the touchscreen.



CAUTION! *Wait to turn off the power switch (step 6) until the LED indicator light of the control button has turned red. Turning off the power switch when the system is still active can cause damage to the PC module.*

Shut down automatically

When no active input source has been detected in a specific input channel, a notification will appear after 1 minute to shut down the touchscreen. This notification will be automatically accepted after 15 seconds by the system and the touchscreen will be shut down.



PLEASE NOTE! *Turn the touchscreen off completely when moving the screen by turning off the power switch and removing the power cable from the screen.*

5.2. Starting your device for the first time

The first time you start your touchscreen, a setup guide opens to help you configure the most important settings. Follow the steps below to complete the setup:

1. Ensure the touchscreen is connected to the mains power supply.
2. Turn on the main power switch.
3. Press the power button (control button or remote control)
4. The touchscreen will turn on and the setup guide will appear.
5. Follow the steps of the setup guide to complete the setup.
6. Once you are connected to the internet the touchscreen will automatically check for updates.
7. The welcome screen will appear and the Prowise Central environment will open right after that.
8. Open the Prowise Central menu to get started on your touchscreen. Open the menu by placing 5 fingers of one hand on the screen for at least 2 seconds, by pressing the menu tab or by using the control button.

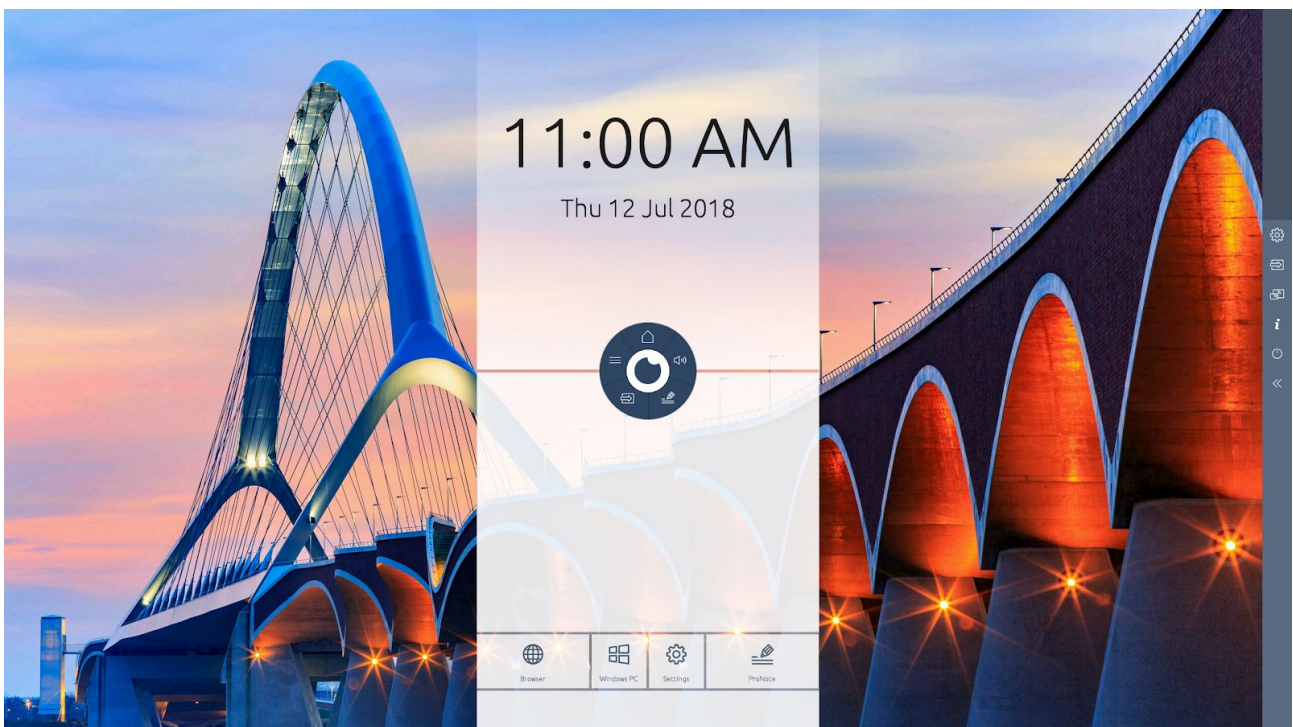

5.3. Connect to a network

Connect your touchscreen to a wireless WiFi network or via a network cable.

Ethernet

Connect the network cable to the LAN port of your touchscreen. The touchscreen will automatically detect the network and connect to it as soon as 'Ethernet' has been activated in the settings menu.

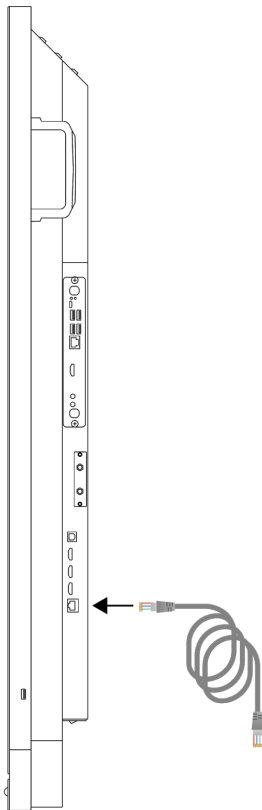

Follow the steps below to view the specifications of the network:

1. Place five fingers on the screen for at least 2 seconds to launch the Prowise Central menu
2. Open the sidebar to access the settings menu
3. Select the submenu 'Connectivity'
4. Select 'Ethernet' by activating the toggle
5. The network specifications will be displayed

WiFi connection

Follow the steps below to set up a connection to a WiFi network:

1. Make sure the WiFi module is installed correctly
2. Place five fingers on the screen for at least 2 seconds to launch the Prowise Central menu
3. Open the sidebar to access the settings menu
4. Select the submenu 'Connectivity'
5. Select 'WiFi'. The touchscreen will scan for available networks
6. Select the preferred network. Click the 'Advanced' button if you want to connect with an advanced network
7. Enter the password of the network. Select the eye icon if you wish to display the characters of the password
8. Press the 'Connect' button to connect to the wireless network

5.4. Adjust volume

The volume of the touchscreen can be adjusted in different ways:

- With the remote control:
 - Use the volume buttons to adjust the volume.
- With the Central Menu:
 1. Place five fingers of one hand on the screen for at least 2 seconds to launch the Prowise Central menu.
 2. Select the 'audio' icon.
 3. Adjust the volume by selecting the the '+' or '-' button or move by moving the slider to increase or reduce the volume.



6. Prowise Central



PLEASE NOTE! *In the future, extra functionalities will be added to Prowise Central. The updates for Central will be installed on the touchscreen via OTA updates. More information about OTA updates can be found in "OTA (Over The Air) updates".*

6.1. Prowise Central home

Prowise Central is the clever and intuitive operating system of Prowise integrated in the Prowise Touchscreen. Central brings everything together in one place.

Navigate quickly and easily to all main features and applications of your touchscreen.

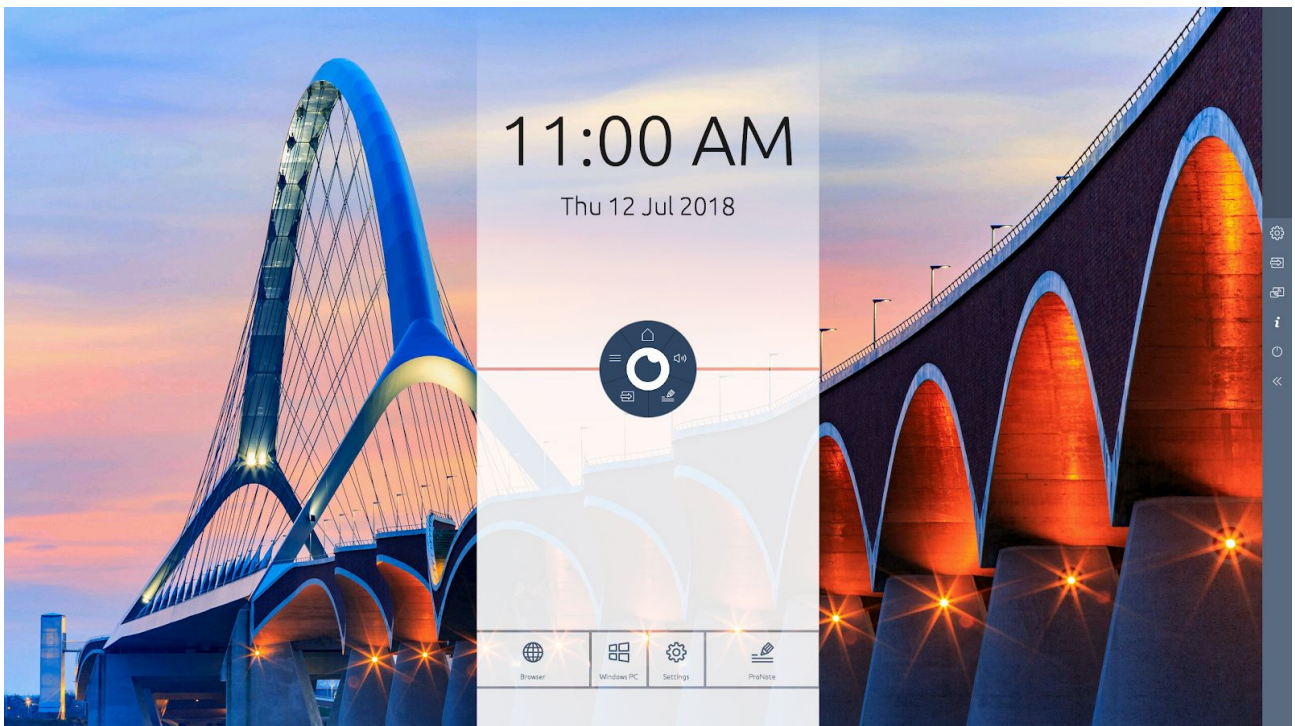

6.2. The Prowise Central menu



Easily adjust the settings of the touchscreen and open ProNote and other applications in the Prowise Central menu.

Change the position of the Prowise Central menu by dragging the circle over the screen and dropping it at your preferred position. The position of the sidebar can also be changed by selecting the arrows at the side of the screen. The sidebar will be displayed when opening the Prowise Central menu.

Launch Prowise Central menu

You can launch the Prowise Central menu in different ways:

- Place five fingers of one hand on the screen for at least 2 seconds.
- Press the Prowise Central menu button on the remote control.
- Press the menu tab on the right hand side of the touchscreen.
- Press the control button of the touchscreen.

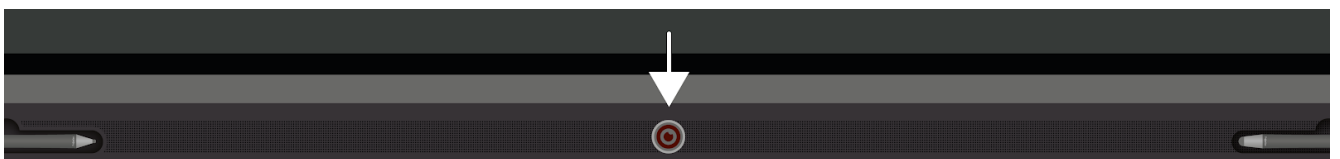
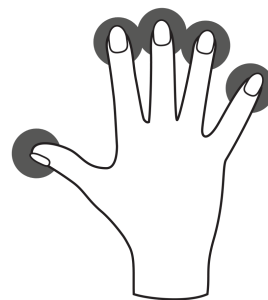

Close the Prowise Central menu

Click on the middle of the eye (inside circle of the Central menu) to close the Prowise Central menu or press the “back” button on the remote control. The sidebar will close as well.

7. Adjust settings

The settings menu of Central is located in the sidebar. Here you can adjust multiple settings of your Prowise Touchscreen, such as: display and audio settings, connectivity, NFC and other settings.

For more information about adjusting the settings in Prowise Central, please read the Prowise Central manual.

8. OTA (Over The Air) updates

OTA updates – over-the-air updates – ensure that you always have the latest software version installed on the touchscreen. The only thing required for OTA updates is a connection to the Internet with Prowise Central, which can be either a WiFi connection or an ethernet connection.

Automatic (OTA) updates are activated by default. The updates are installed when the touchscreen gets turned off. This function can be turned off in the “General Settings” menu. However, Prowise recommends always having OTA updates activated.









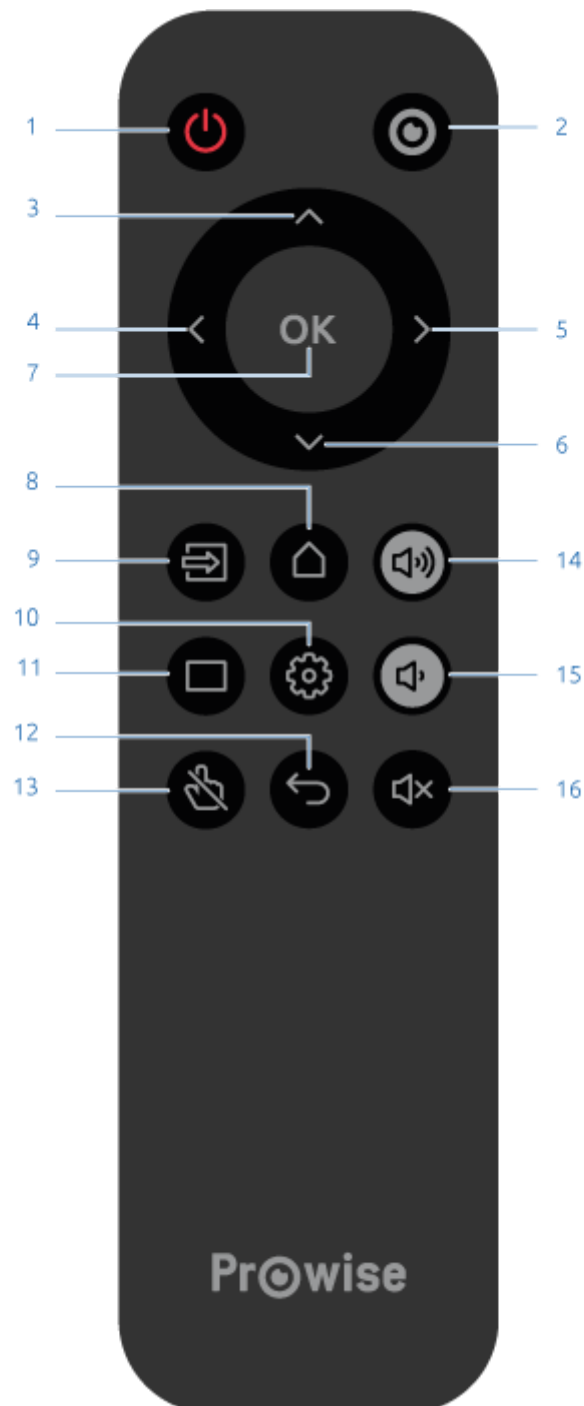







PLEASE NOTE! *OTA updates require a WiFi or an ethernet (wired network) connection to Prowise Central.*

9. Remote control

9.1. Schematic view and explanation of the buttons



1		Press this button to turn the touchscreen on or off. To turn the touchscreen off, press this button and then press Enter to confirm.
2		Opens the Prowise Central menu.
3		Navigation button – up
4		Navigation button – Left
5		Navigation button – Right
6		Navigation button – Down
7	OK	Confirm selection.
8		If an input other than Prowise Central home is active, this button can be used to return to Prowise Central home.
9		Opens the Prowise Central input selection.
10		Opens the Prowise Central settings menu.
11		Temporarily disables the screen. This is depicted in the form of a black screen.
12		Go back one menu. If Central menu is active then this closes the menu
13		Enable or disable the IR touch functionality of the touchscreen.
14		Increase the volume level
15		Lower the volume level
16		Enable or disable the internal speakers of the touchscreen.

9.2. Angle at which the remote control is used

To use the remote control, point it to the IR receiver of the touchscreen (bottom right corner of the touchscreen). The remote control has a range of around 8 metres.



CAUTION! *If any obstacles are situated between the remote control and the receiver of the touchscreen, the remote control may not work properly.*

9.3. Replacing the batteries of the remote control

Before using the remote control for the first time, you must insert the two (1.5V AAA) batteries, supplied with the remote control. Once the batteries are running out and the remote control is no longer working properly, you must change the batteries. You can do this as follows:

1. Carefully remove the cover plate on the reverse side of the remote control.
2. Insert the two batteries (1.5V, AAA) into the remote control.
3. Place them with the positive and negative poles as indicated by the (+) and (-) signs in the battery compartment.
4. Close the battery compartment again by carefully replacing the cover plate.

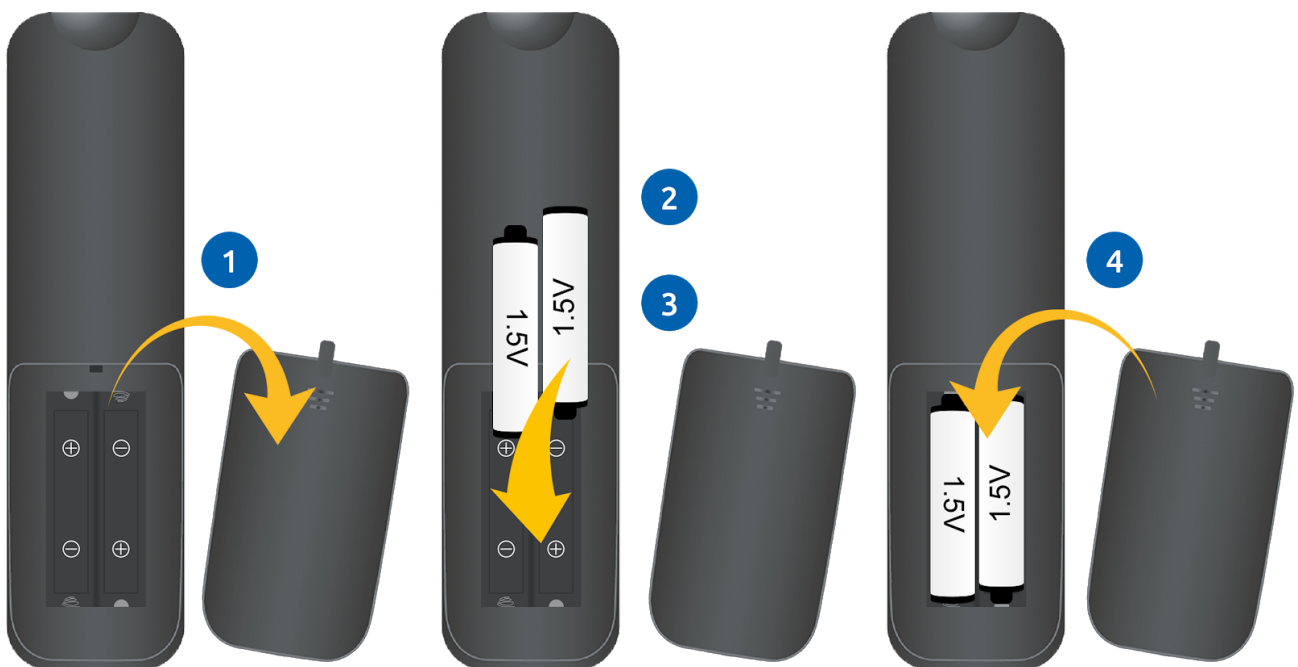

WARNING! Remove any leaking batteries as quickly as possible from the remote control. Thoroughly wash your hands afterwards. The leaking chemicals are toxic and must never come into contact with the mouth, skin or eyes.



PLEASE NOTE! Only use 1.5 V AAA batteries. Insert them as shown by the instructions on the remote control.

10. Connect peripherals

10.1. Connect the Prowise Touchscreen to an external PC

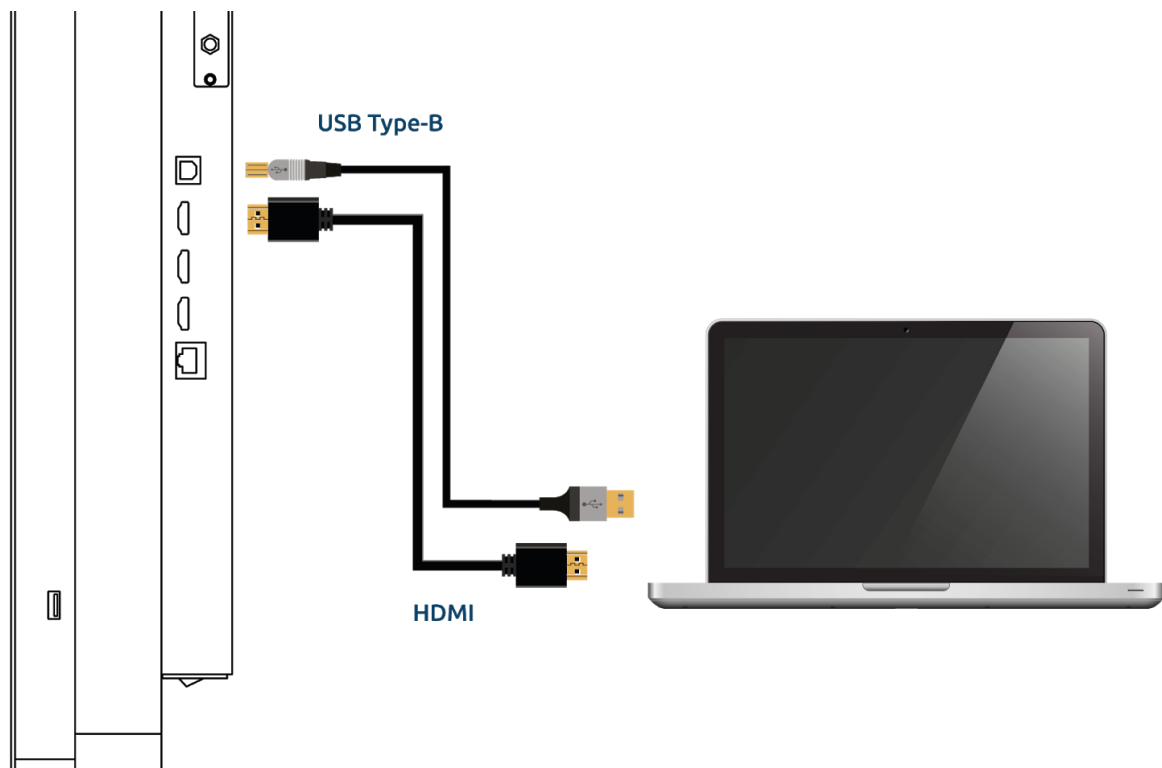

In addition to an HDMI connection, a USB touch connection is also available on the right-hand side of the touchscreen. This can be used to connect an external PC with touch functionality.

1. Connect an HDMI cable to the HDMI port of the external PC and to the HDMI input port of the touchscreen.
2. Connect the USB touch cable to the touch USB port of the touchscreen and to a USB port on the external PC.
3. Once all cables have been connected, switch on the touchscreen and the external PC.
4. Once the touchscreen and the external PC have booted up, navigate in the Central menu to 'Input' and select the correct HDMI source.



PLEASE NOTE! We recommend using a cable that is as short as possible for the best connection quality and is no longer than 3 metres.

10.2. Connecting the Prowise Touchscreen to audio equipment

10.2.1. Connecting headphones

Connect headphones by plugging them into the analogue audio output “headphones”. Use the touchscreen’s volume control to adjust the headphones volume.

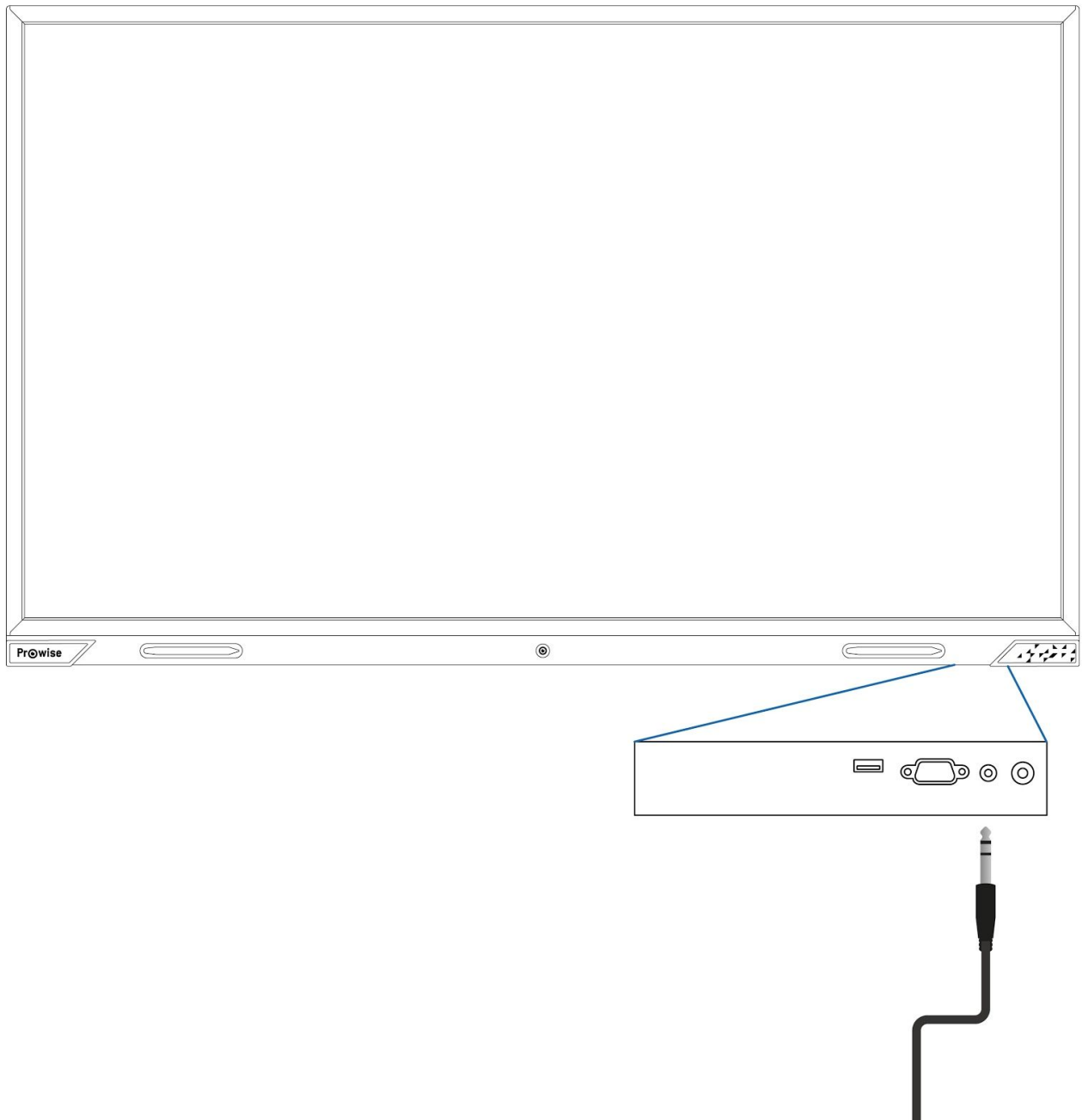

10.2.2. Connecting an amplifier

Connect an amplifier by plugging it into the analogue audio output or the digital coax port. Use the amplifier's volume control to adjust the amplifier's volume.

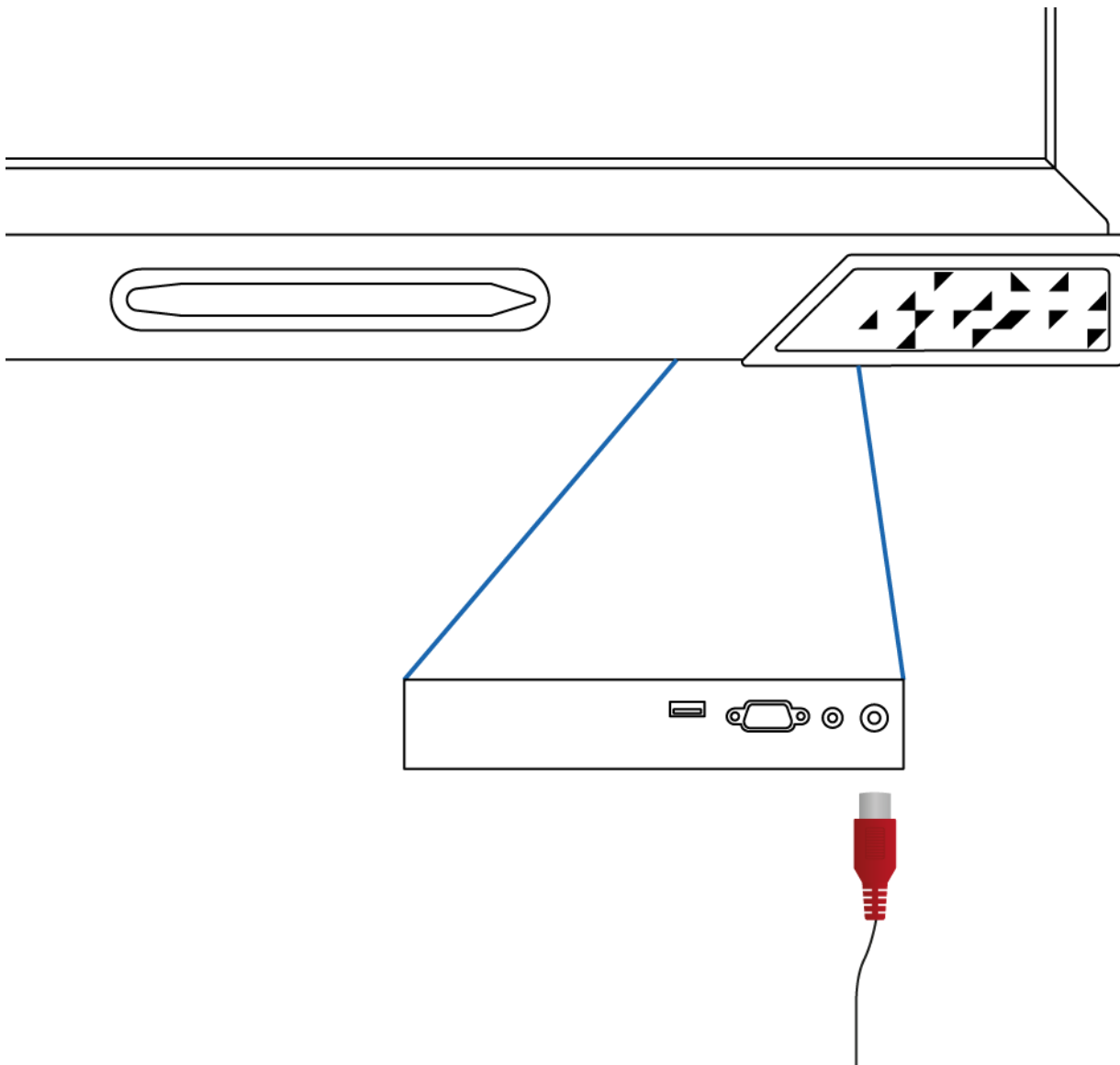

PLEASE NOTE! *The audio outputs (the analogue line output and the digital Coax port) are always active. If you connect an external audio device to the touchscreen and only wish to use this audio device, press the "Mute" button on the remote control or in the Central menu to turn off the touchscreen's internal speakers.*

10.2.3. Connecting using the HDMI port (ARC)

It is possible to connect an external audio device using an ARC (Audio Return Channel) connection. This allows the external audio device to be controlled via the touchscreen. To connect an audio device via ARC, insert one end of an HDMI cable into the touchscreen's HDMI port with ARC support (3) and the other end in the external audio device's HDMI port.

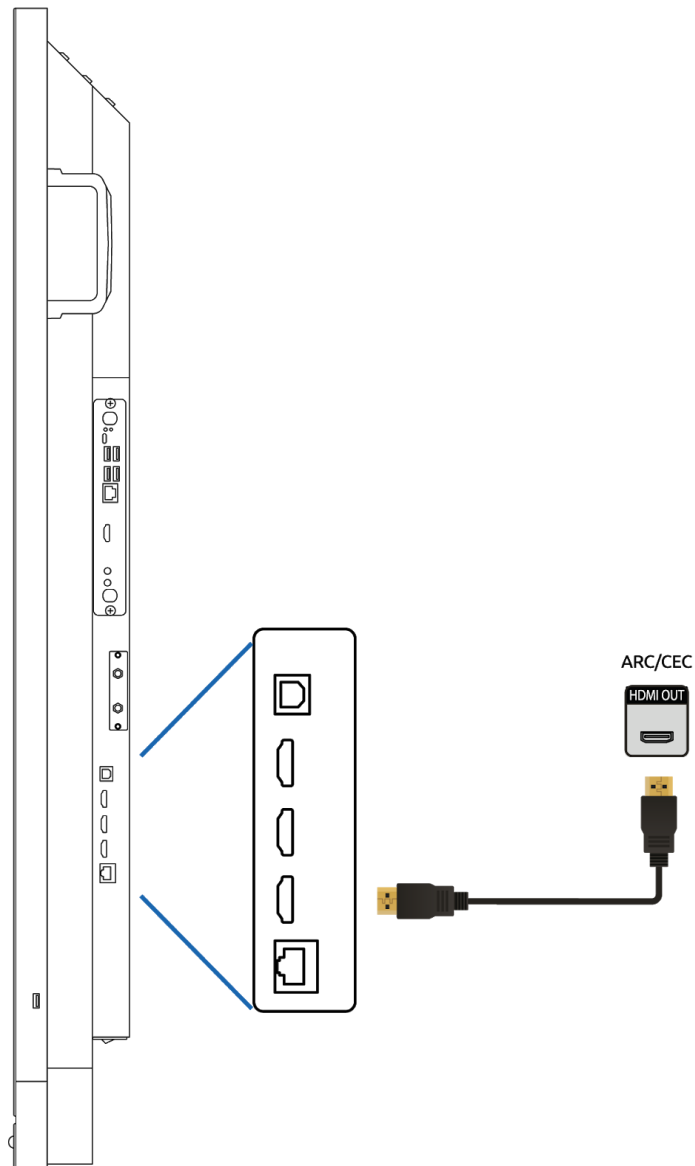

10.2.4. Connecting using the HDMI port (CEC)

CEC (Consumer Electronics Control) is a functionality that works via HDMI. The devices that are connected to each other in this way communicate via CEC. This allows these devices to be controlled via the touchscreen's remote control.

Connect a device via CEC by inserting an HDMI cable in the touchscreen's HDMI port (3).

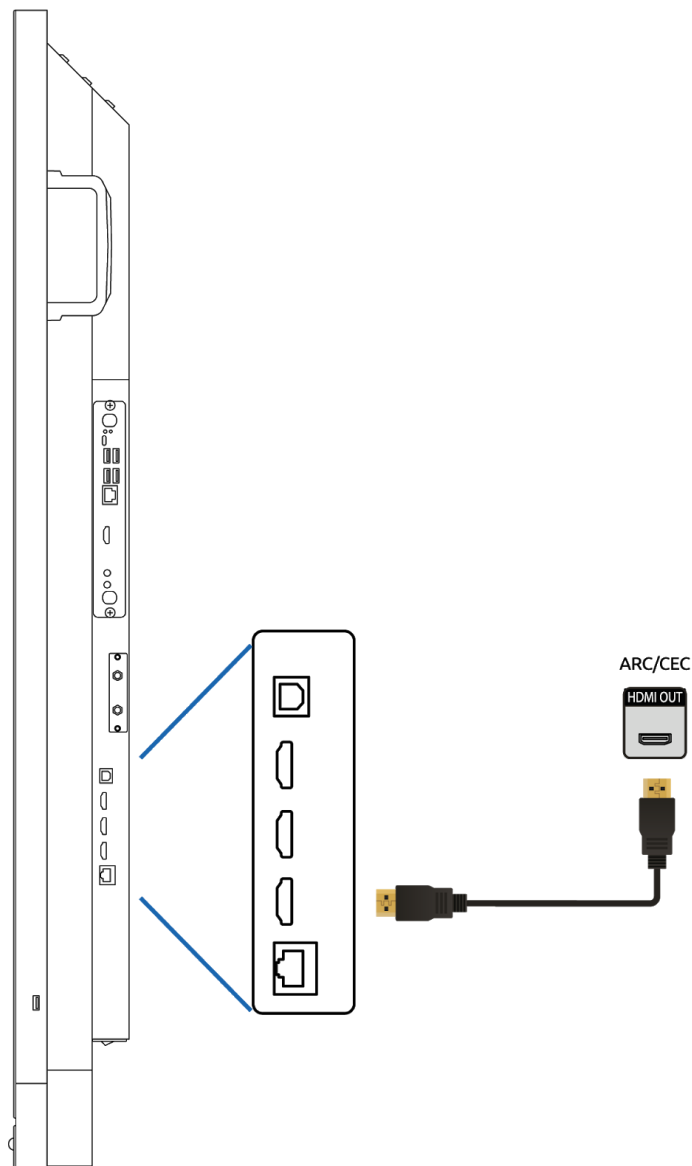

Appendix

RS232 protocol and code list

This appendix describes the hardware interface specification and software protocols of RS232 interface communication between the touchscreen and the connected PC or other control unit with RS232 protocol.

**Male DSUB 9Pin
(outside view)**



Pin #	Signal	Remark
1	NC	
2	TXD	Output to TV
3	RXD	Input from TV
4	NC	
5	GND	
6	NC	
7	NC	
8	NC	
9	NC	
frame	GND	

Pin2 is TXD Pin3 is RXD. Pin to Pin connection as below.

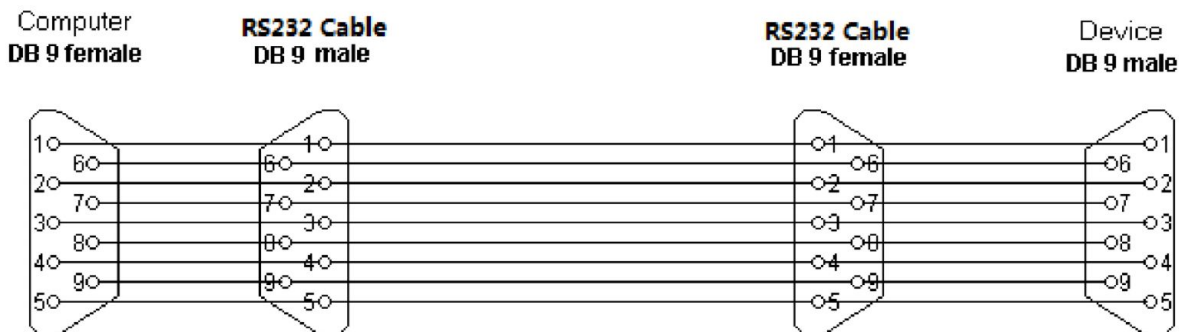

Serial Port Settings

Items	Value
Baud Rate	115200bps (fixed)
Data Bits	8 (fixed)
Stop Bits	1 (fixed)
Parity	None (fixed)
Stream Control	None (fixed)

Protocol description

Command format

Version	0.9
Command Head	AA BB CC
Command Body	3 bytes + 1 byte checksum(of leading 3 bytes)
Command Tail	DD EE FF

RS232 code list

Category	Function	Code	Remark
Power	Power on	AA BB CC 01 00 00 01 DD EE FF	
	Power off	AA BB CC 01 01 00 02 DD EE FF	
Source	HDMI 1	AA BB CC 02 06 00 08 DD EE FF	
	HDMI 2	AA BB CC 02 07 00 09 DD EE FF	
	HDMI 3	AA BB CC 02 05 00 07 DD EE FF	
	PC	AA BB CC 02 08 00 0A DD EE FF	
	Android	AA BB CC 02 0A 00 0C DD EE FF	
Audio	Volume	AA BB CC 03 00 value checksum DD EE FF	value 0 <-> 100 (hex code)
	Mute	AA BB CC 03 01 00 04 DD EE FF	
	Unmute	AA BB CC 03 01 01 05 DD EE FF	
	Bass	AA BB CC 03 07 value checksum DD EE FF	value 0 <-> 100 (hex code)
	Treble	AA BB CC 03 08 value checksum DD EE FF	value 0 <-> 100 (hex code)
	Balance	AA BB CC 03 04 value checksum DD EE FF	value -50 <-> 50 (hex code)
	Audio preset: Standard	AA BB CC 03 06 00 09 DD EE FF	
	Audio preset: Movie	AA BB CC 03 06 01 0A DD EE FF	
	Audio preset : Meeting	AA BB CC 03 06 02 0B DD EE FF	
	Audio preset: Classroom	AA BB CC 03 06 03 0C DD EE FF	
Audio preset : Custom	AA BB CC 03 06 04 0D DD EE FF		
Display	Brightness	AA BB CC 08 09 value checksum DD EE FF	value 0 <-> 100 (hex code)
	Contrast	AA BB CC 08 0A value checksum DD EE FF	value 0 <-> 100 (hex code)
	Display preset : Normal	AA BB CC 08 0D 00 15 DD EE FF	
	Display preset: Dynamic	AA BB CC 08 0D 01 16 DD EE FF	
	Display preset: Vivid	AA BB CC 08 0D 02 17 DD EE FF	
	Display preset: Soft	AA BB CC 08 0D 03 18 DD EE FF	
	Display preset: User	AA BB CC 08 0D 04 19 DD EE FF	

Settings	Language: English	AA BB CC 38 02 00 3A DD EE FF	
	Language: Dutch	AA BB CC 38 02 01 3B DD EE FF	
	Language: German	AA BB CC 38 02 02 3C DD EE FF	
	Language : French	AA BB CC 38 02 03 3D DD EE FF	
	Language: Italian	AA BB CC 38 02 04 3E DD EE FF	
	Language: Spanish	AA BB CC 38 02 05 3F DD EE FF	
	Language: Swedish	AA BB CC 38 02 06 40 DD EE FF	
	Language: Norwegian	AA BB CC 38 02 07 41 DD EE FF	
	Language: Danish	AA BB CC 38 02 08 42 DD EE FF	
	User menu: 5 fingers gesture off	AA BB CC 38 03 00 3B DD EE FF	
	User menu: 5 Fingers gesture on	AA BB CC 38 03 01 3C DD EE FF	
	Key lock: Off	AA BB CC 38 04 00 3C DD EE FF	
	Key lock: On	AA BB CC 38 04 01 3D DD EE FF	
	IR lock: Off	AA BB CC 38 05 00 3D DD EE FF	
	IR lock: On	AA BB CC 38 05 01 3E DD EE FF	
	Touch: Off	AA BB CC 38 07 00 3F DD EE FF	
	Touch: On	AA BB CC 38 07 01 40 DD EE FF	
PC	PC Power ON	AA BB CC 09 01 00 0A DD EE FF	
	PC Power OFF	AA BB CC 09 00 00 09 DD EE FF	
RC	WIN	AA BB CC 07 0B 00 12 DD EE FF	
	Space	AA BB CC 07 46 00 4D DD EE FF	
	Alt+Tab	AA BB CC 07 1D 00 24 DD EE FF	
	Alt+F4	AA BB CC 07 1F 00 26 DD EE FF	
	NUM_1	AA BB CC 07 00 00 07 DD EE FF	
	NUM_2	AA BB CC 07 10 00 17 DD EE FF	
	NUM_3	AA BB CC 07 11 00 18 DD EE FF	
	NUM_4	AA BB CC 07 13 00 1A DD EE FF	
	NUM_5	AA BB CC 07 14 00 1B DD EE FF	
	NUM_6	AA BB CC 07 15 00 1C DD EE FF	
	NUM_7	AA BB CC 07 17 00 1E DD EE FF	
	NUM_8	AA BB CC 07 18 00 1F DD EE FF	
	NUM_9	AA BB CC 07 19 00 20 DD EE FF	
	NUM_0	AA BB CC 07 1B 00 22 DD EE FF	
	Freeze/Unfreeze	AA BB CC 07 1C 00 23 DD EE FF	
	Display	AA BB CC 07 4C 00 53 DD EE FF	
	Input	AA BB CC 07 07 00 0E DD EE FF	
	Home	AA BB CC 07 48 00 4F DD EE FF	
	Menu	AA BB CC 07 0D 00 14 DD EE FF	
	Backspace	AA BB CC 07 40 00 47 DD EE FF	
	Blank screen	AA BB CC 07 4E 00 55 DD EE FF	
	Up	AA BB CC 07 47 00 4E DD EE FF	
	Down	AA BB CC 07 4D 00 54 DD EE FF	
	Left	AA BB CC 07 49 00 50 DD EE FF	

	Right	AA BB CC 07 4B 00 52 DD EE FF	
	Enter	AA BB CC 07 4A 00 51 DD EE FF	
	Back / Escape	AA BB CC 07 0A 00 11 DD EE FF	
	VOL+	AA BB CC 07 03 00 0A DD EE FF	
	VOL-	AA BB CC 07 41 00 48 DD EE FF	
	PageUp	AA BB CC 07 42 00 49 DD EE FF	
	PageDown	AA BB CC 07 0F 00 16 DD EE FF	
	F1	AA BB CC 07 45 00 4C DD EE FF	
	F2	AA BB CC 07 12 00 19 DD EE FF	
	F3	AA BB CC 07 51 00 58 DD EE FF	
	F4	AA BB CC 07 5B 00 62 DD EE FF	
	F5	AA BB CC 07 44 00 4B DD EE FF	
	F6	AA BB CC 07 50 00 57 DD EE FF	
	F7	AA BB CC 07 43 00 4A DD EE FF	
	F8	AA BB CC 07 1A 00 21 DD EE FF	
	F9	AA BB CC 07 04 00 0B DD EE FF	
	F10	AA BB CC 07 59 00 60 DD EE FF	
	F11	AA BB CC 07 57 00 5E DD EE FF	
	F12	AA BB CC 07 08 00 0F DD EE FF	
	Shift + F10	AA BB CC 07 16 00 1D DD EE FF	
	Red	AA BB CC 07 5C 00 63 DD EE FF	
	Green	AA BB CC 07 5D 00 64 DD EE FF	
	Yellow	AA BB CC 07 5E 00 65 DD EE FF	
	Blue	AA BB CC 07 5F 00 66 DD EE FF	
Custom	Custom	AA BB CC 07 09 value checksum DD EE FF	

Polling code list

Mode	Function	External Host Command	System Response	Actual Status
Power	Obtain power	AA BB CC 01 02 00 03 DD EE FF	AA BB CC 80 00 00 80 DD EE FF	POWER_ON
			AA BB CC 80 01 00 81 DD EE FF	POWER_STANDY
Source	Obtain source	AA BB CC 02 00 00 02 DD EE FF	AA BB CC 81 06 00 87 DD EE FF	HDMI1
			AA BB CC 81 07 00 88 DD EE FF	HDMI2
			AA BB CC 81 05 00 86 DD EE FF	HDMI3
			AA BB CC 81 08 00 89 DD EE FF	PC
			AA BB CC 81 0A 00 8B DD EE FF	Prowise Central
Audio	Obtain volume	AA BB CC 03 02 00 05 DD EE FF	AA BB CC 82 00 value checksum DD EE FF	VOLUME - value (hex code)
	Obtain mute	AA BB CC 03 03 00 06 DD EE FF	AA BB CC 82 01 00 83 DD EE FF	MUTED
			AA BB CC 82 01 01 84 DD EE FF	UNMUTED
	Obtain bass	AA BB CC 39 08 00 41 DD EE FF	AA BB CC 40 08 value checksum DD EE FF	BASS - value (hex code)
	Obtain treble	AA BB CC 39 09 00 42 DD EE FF	AA BB CC 40 09 value checksum DD EE FF	TREBLE - value (hex code)
	Obtain balance	AA BB CC 39 0A 00 43 DD EE FF	AA BB CC 40 0A value checksum DD EE FF	BALANCE value (hex code)
	Obtain preset	AA BB CC 39 0B 00 44 DD EE FF	AA BB CC 40 0B 00 4B DD EE FF	AUDIO_PRESET_STANDARD
			AA BB CC 40 0B 01 4C DD EE FF	AUDIO_PRESET_MOVIE
			AA BB CC 40 0B 02 4D DD EE FF	AUDIO_PRESET_MEETING
			AA BB CC 40 0B 03 4E DD EE FF	AUDIO_PRESET_CLASSROOM
		AA BB CC 40 0B 04 4F DD EE FF	AUDIO_PRESET_USER	
Display	Obtain brightness	AA BB CC 39 02 00 3B DD EE FF	AA BB CC 40 02 value checksum DD EE FF	BRIGHTNESS - value (hex code)
	Obtain contrast	AA BB CC 39 03 00 3C DD EE FF	AA BB CC 40 03 value checksum DD EE FF	CONTRAST - value (hex code)
	Obtain preset	AA BB CC 39 06 00 3F DD EE FF	AA BB CC 40 06 00 46 DD EE FF	DISPLAY_PRESET_STANDARD
			AA BB CC 40 06 01 47 DD EE FF	DISPLAY_PRESET_DYNAMIC
			AA BB CC 40 06 02 48 DD EE FF	DISPLAY_PRESET_VIVID
			AA BB CC 40 06 03 49 DD EE FF	DISPLAY_PRESET_SOFT
		AA BB CC 40 06 04 4A DD EE FF	DISPLAY_PRESET_USER	
Settings	Obtain language	AA BB CC 39 0F 00 48 DD EE FF	AA BB CC 40 0F 00 4F DD EE FF	ENGLISH
			AA BB CC 40 0F 01 50 DD EE FF	DUTCH
			AA BB CC 40 0F 02 51 DD EE FF	GERMAN
			AA BB CC 40 0F 03 52 DD EE FF	FRENCH
			AA BB CC 40 0F 04 53 DD EE FF	ITALIAN
			AA BB CC 40 0F 05 54 DD EE FF	SPANISH
			AA BB CC 40 0F 06 55 DD EE FF	SWEDISH
			AA BB CC 40 0F 07 56 DD EE FF	NORWEGIAN

			AA BB CC 40 0F 08 57 DD EE FF	DANISH
	Obtain gesture	AA BB CC 39 10 00 49 DD EE FF	AA BB CC 40 10 00 50 DD EE FF	GESTURE_OFF
			AA BB CC 40 10 01 51 DD EE FF	GESTURE_ON
	Obtain keylock	AA BB CC 39 00 00 39 DD EE FF	AA BB CC 40 00 00 40 DD EE FF	KEY_LOCK_OFF
			AA BB CC 40 00 01 41 DD EE FF	KEY_LOCK_ON
	Obtain IR lock	AA BB CC 39 01 00 3A DD EE FF	AA BB CC 40 01 00 41 DD EE FF	IR_LOCK_OFF
			AA BB CC 40 01 01 42 DD EE FF	IR_LOCK_ON
	Obtain touch	AA BB CC 39 12 00 4B DD EE FF	AA BB CC 40 12 00 52 DD EE FF	TOUCH_OFF
			AA BB CC 40 12 01 53 DD EE FF	TOUCH_ON
PC	Obtain pc state	AA BB CC 09 02 00 0B DD EE FF	AA BB CC 83 01 00 84 DD EE FF	PC_ON
			AA BB CC 83 00 00 83 DD EE FF	PC_OFF
			AA BB CC 83 02 00 85 DD EE FF	PC_SLEEP
Other	Obtain freeze	AA BB CC 34 02 00 36 DD EE FF	AA BB CC 34 03 01 38 DD EE FF	FREEZE_ON
			AA BB CC 34 03 00 37 DD EE FF	FREEZE_OFF
	Obtain blank screen	AA BB CC 35 02 00 37 DD EE FF	AA BB CC 35 03 01 39 DD EE FF	BLANK_SCREEN_ON
			AA BB CC 35 03 00 38 DD EE FF	BLANK_SCREEN_OFF
	Obtain sleep timer	AA BB CC 39 0D 00 46 DD EE FF	AA BB CC 40 0D value checksum DD EE FF	SLEEP_TIMER
Custom	Obtain custom item	AA BB CC 39 07 00 40 DD EE FF	AA BB CC 40 07 value checksum DD EE FF	CUSTOM